

CONTROL 1X

Personal-Size Monitor Loudspeaker



thank you for choosing JBL. For more than 50 years, JBL has been involved in every aspect of music and film recording and reproduction, from live performances to the recordings you play in your home, car or office.

We're confident that the JBL loudspeakers you have chosen will provide every note of enjoyment that you expected – and that when you think about purchasing additional audio equipment for your home, car or office, you will once again choose JBL.

Please take a moment to complete the enclosed profile card. It enables us to keep you posted on our latest advancements, and helps us to better understand our customers and build products that meet their needs and expectations.

JBL Consumer Products

included

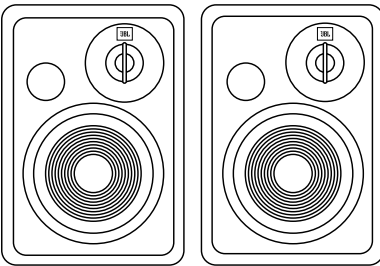

features

- Rugged, high-impact molded-plastic cabinet
- Video-shielded
- Optional adjustable wall-mount brackets available

one. Speaker Placement

As front speakers

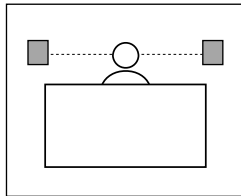
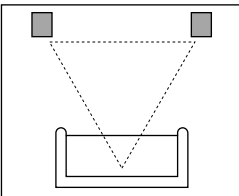

As rear speakers

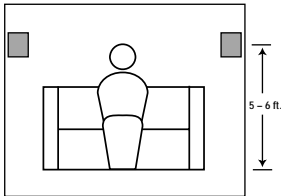
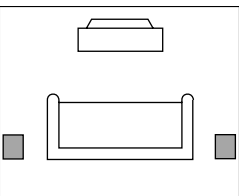

two. Speaker Connections

connection tips

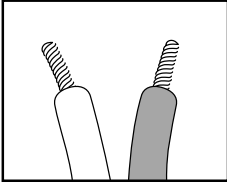

Speakers and electronics terminals have corresponding (+) and (-) terminals. It is important to connect both speakers identically: (+) on the speaker to (+) on

the amplifier and (-) on the speaker to (-) on the amplifier. Wiring “out of phase” results in thin sound, weak bass and a poor stereo image.

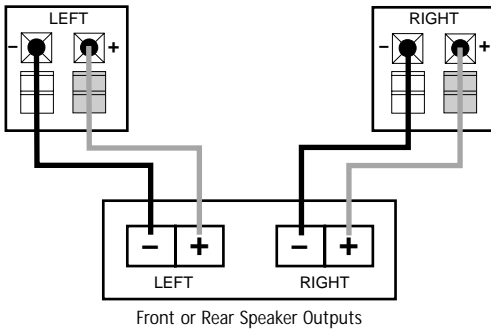

three. Wall-Mounting

The Control 1X loudspeakers may be wall-mounted. This product is not intended for ceiling mounting. Optional

adjustable wall-mount brackets are available from JBL. Contact your dealer or call 800-336-4JBL for a dealer near you.

Troubleshooting

If there is no sound from any of the speakers:

- Check that receiver/ amplifier is on and a source is playing.
- Review proper operation of your receiver/amplifier.

If there is no sound coming from one speaker:

- Check the “Balance” control on your receiver/ amplifier.
- Check all wires and connections between receiver/ amplifier and speakers.

- Make sure all wires are connected. Make sure none of the speaker wires are frayed, cut or punctured.

If the system plays at low volumes but shuts off as volume is increased:

- Check all wires and connections between receiver/ amplifier and speakers.
- Make sure all wires are connected. Make sure none of the speaker wires are frayed, cut or punctured.

- If more than one pair of main speakers is being used, check the minimum impedance requirements of your receiver/amplifier.

If there is no (or low) bass output:

- Make sure the polarities (+ and –) of the left and right “Speaker Inputs” are connected properly.

Specifications

High-Frequency Driver	1/2" Titanium-laminate, shielded
Low-Frequency Driver	4", Shielded
Crossover Frequency	4,000Hz
Frequency Response	80Hz – 20kHz
Sensitivity	89dB
Nominal Impedance	8 Ohms
Recommended Amplifier Power Range	10 – 80 Watts
Dimensions (H x W x D)	9 x 6-1/16 x 5-7/16" 228 x 155 x 139mm
Weight (each)	5.2 lbs/2.4 kg

Notice to Purchaser:

JBL assumes no responsibility or liability for injuries or property damage – direct, indirect or consequential – resulting from the improper installation of Control 1X loudspeakers.

Declaration of Conformity



We, JBL Europe A/S
Køgevej 15 194B
DK-3460 Birkerød
DENMARK

declare in own responsibility, that the product described in this owner's manual is in compliance with technical standards:

EN 50081-1:1992
EN 50082-1:1992

Steen Michaelsen
JBL Europe A/S
Birkerød, DENMARK, 8/99



JBL Consumer Products

250 Crossways Park Drive, Woodbury, NY 11797
8500 Balboa Boulevard, Northridge, CA 91329
1-800-336-4JBL (4525) (USA only)
www.jbl.com

©1999 JBL, Incorporated.

JBL is a registered trademark of JBL, Incorporated.

8/99 Part No. 1111-CTRL1XOM

A Harman International Company